

# McIntosh

## MPI-4

MAXIMUM PERFORMANCE  
INDICATOR

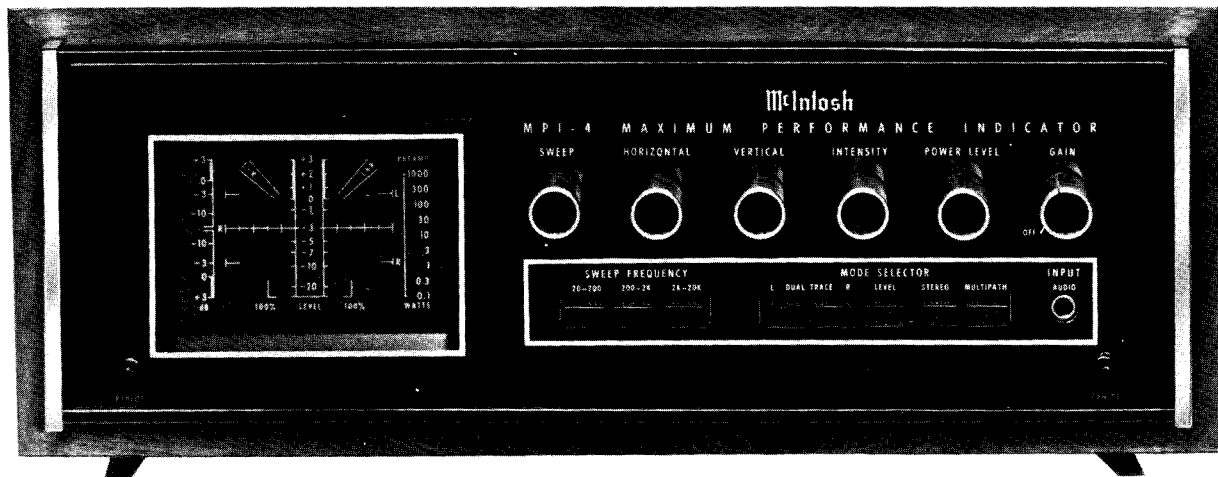

## SERVICE INFORMATION

STARTING WITH SERIAL NO. AF1001

McINTOSH LABORATORY INC. 2 CHAMBERS STREET BINGHAMTON, NEW YORK

MPI-4

## MULTIPATH MODE OF OPERATION

Sensitivity: 100mV/cm  
 Frequency Response: DC to 50,000Hz (-3dB)  
 Input Impedance: 250k $\Omega$   
 Signal Strength Polarity: Selectable  
 positive or negative

## STEREO MODE OF OPERATION

Sensitivity - L (Vertical Amp.): 1.75mV  
 rms/cm (5mV P-P/cm)  
 - R (Horizontal Amp.): 1.75mV  
 rms/cm (5mV P-P/cm)  
 Frequency Response: 5Hz to 50,000Hz (-3dB)  
 Input Impedance: 250k $\Omega$

## POWER LEVEL MODE OF OPERATION

Sensitivity: 0.1 to 1000 average watts for  
 full scale indication (+3dB)  
 in 9 calibrated steps.  
 Frequency Response: 5Hz to 100,000Hz (-3dB)  
 Input Impedance: 75k $\Omega$   
 Calibration: For bridging 4, 8 or 16 ohm  
 speaker loads

## PREAMP LEVEL MODE OF OPERATION

Sensitivity: 15mV rms for +3dB  
 indication  
 Frequency Response: 5Hz to 50kHz  
 Input Impedance: 250k $\Omega$

## SWEEP MODE OF OPERATION

Display modes: Left, right, or both  
 (dual trace)  
 Sensitivity: 1.6mV rms/cm (4.5mV P-P/cm)  
 Frequency Response: 5Hz to 50kHz (-3dB)  
 Input Impedance: 250k $\Omega$   
 Sweep Frequency: 20Hz to 20kHz in 3  
 Decade ranges  
 Sweep Expansion: .25X to 5X  
 Sweep Trigger: The sweep is triggered only  
 in the presence of an input signal.

In the single trace mode it  
 is triggered by the displayed wave-  
 form.

In the dual trace mode the  
 trigger is selectable: Left channel,  
 right channel, or line frequency.

## LEVEL INDICATION MODE

Normal: 250 $\mu$ s rise time  
 500ms decay time  
 Peak: 250 $\mu$ s rise time  
 100 sec decay time  
 Manual reset

## LOW PASS FILTER

16kHz L. P. Filter for stereo and sweep modes  
 19kHz and 38kHz rejected by at least 30dB

## RETICLE LIGHTING

Selectable: On-Off

## CRT

3 inch round tube, calibrated 5 x 6cm  
 1kV accelerating potential

AUTOMATIC INTENSITY CONTROL: In the absence  
 of a horizontal signal, the intensity  
 is reduced to prevent phosphor damage.

## SEMICONDUCTOR COMPLEMENT:

2 integrated circuits  
 23 Transistors  
 10 Light emitting diodes  
 29 Diodes

## POWER SUPPLIES

All are regulated to give equivalent perform-  
 ance for line voltages of 100 to 135 volts.

## POWER REQUIREMENTS

120 volts 50/60Hz 50 watts

## SIZE

Front panel, 16 inches (40.65cm) wide by  
 5-7/16 (13.8cm) high. Chassis, 15 inches  
 (38.1cm) wide by 5 inches (12.7cm) high  
 by 13 inches (33.1cm) deep. Knob clear-  
 ance required, 1-1/2 inches (3.85cm) in  
 front of mounting panel.

## WEIGHT

21 pounds (9.55kg) Net, 33 pounds (15kg)  
 shipping.

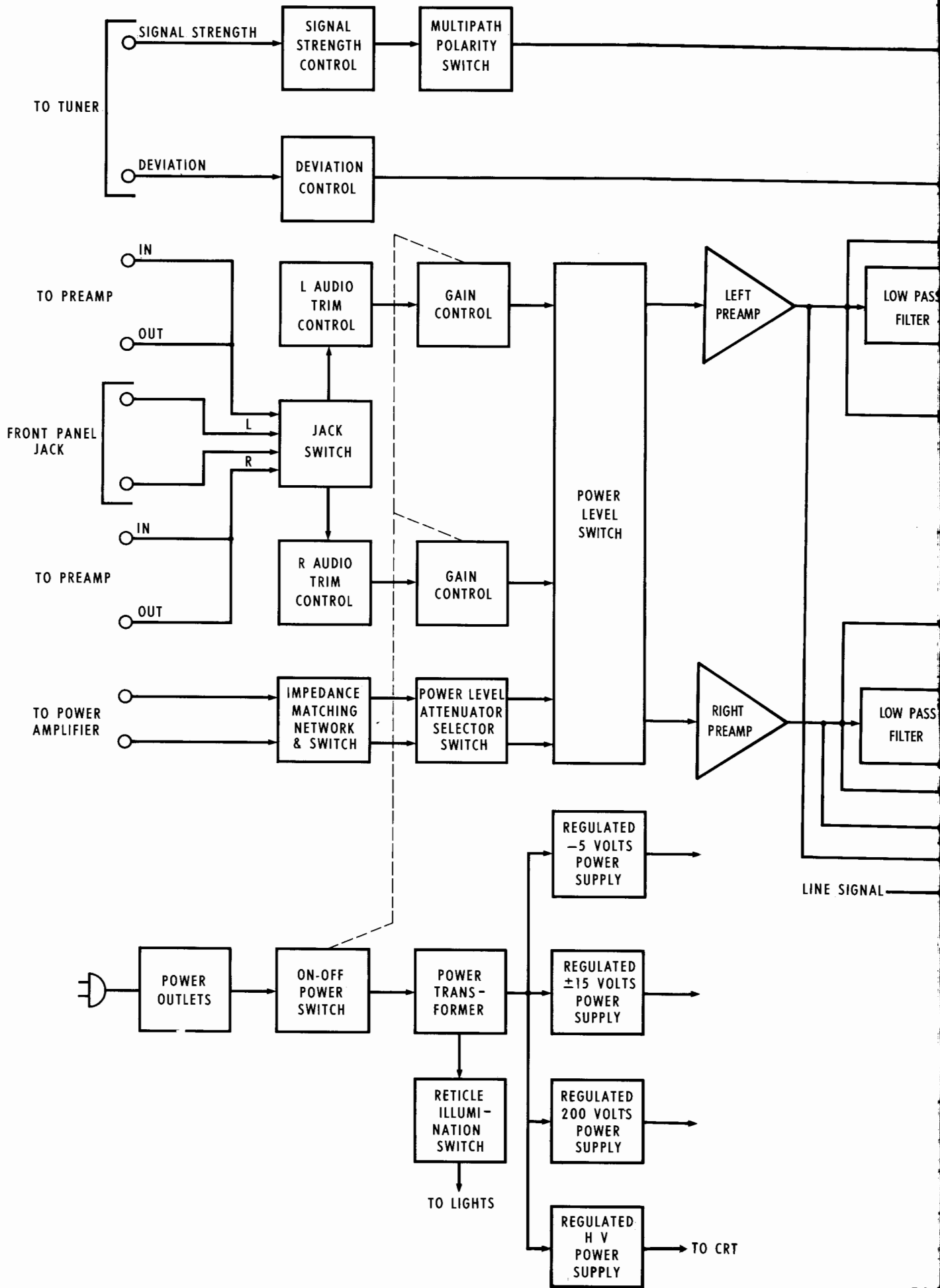

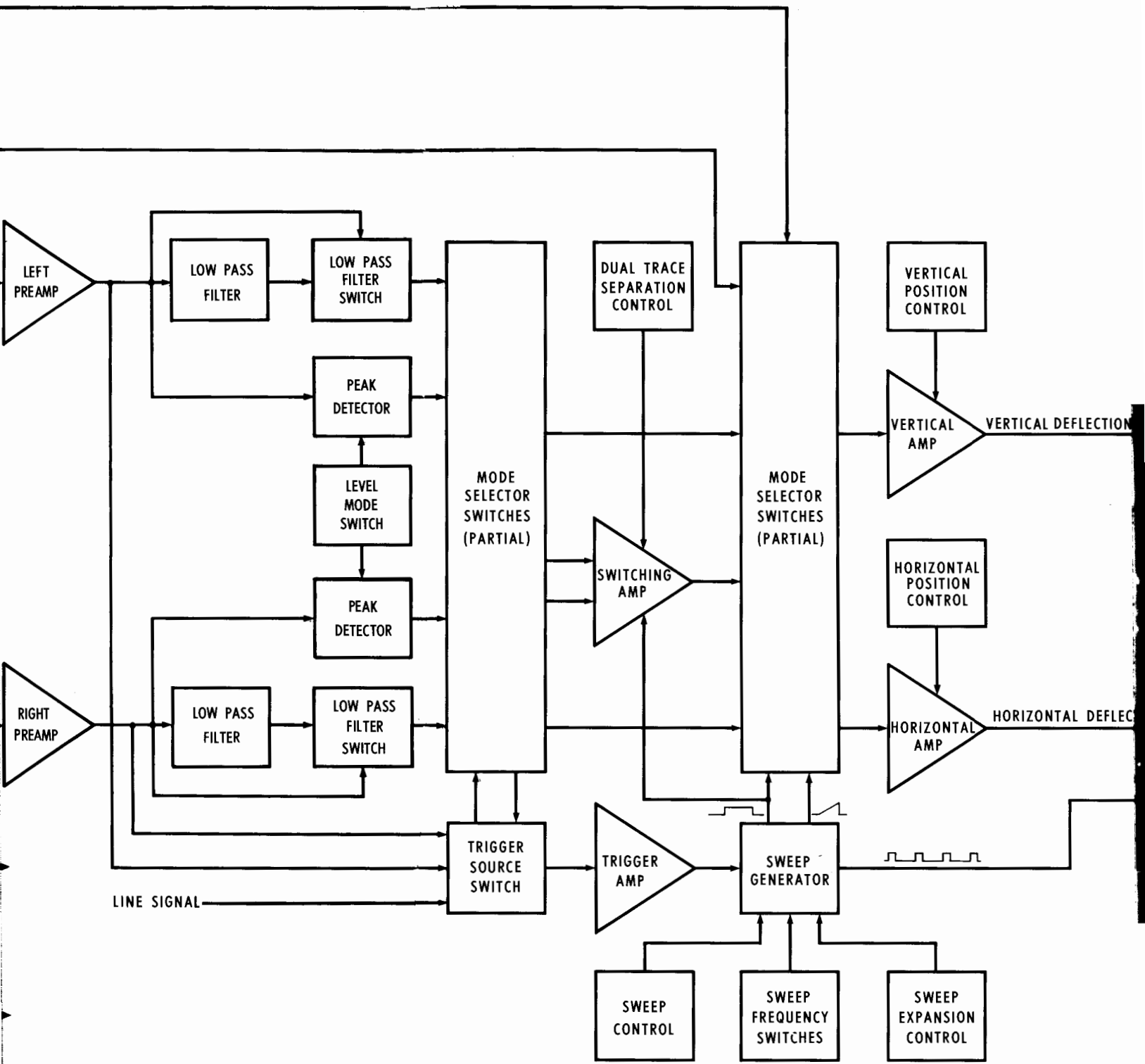

BLOCK DIAGRAM

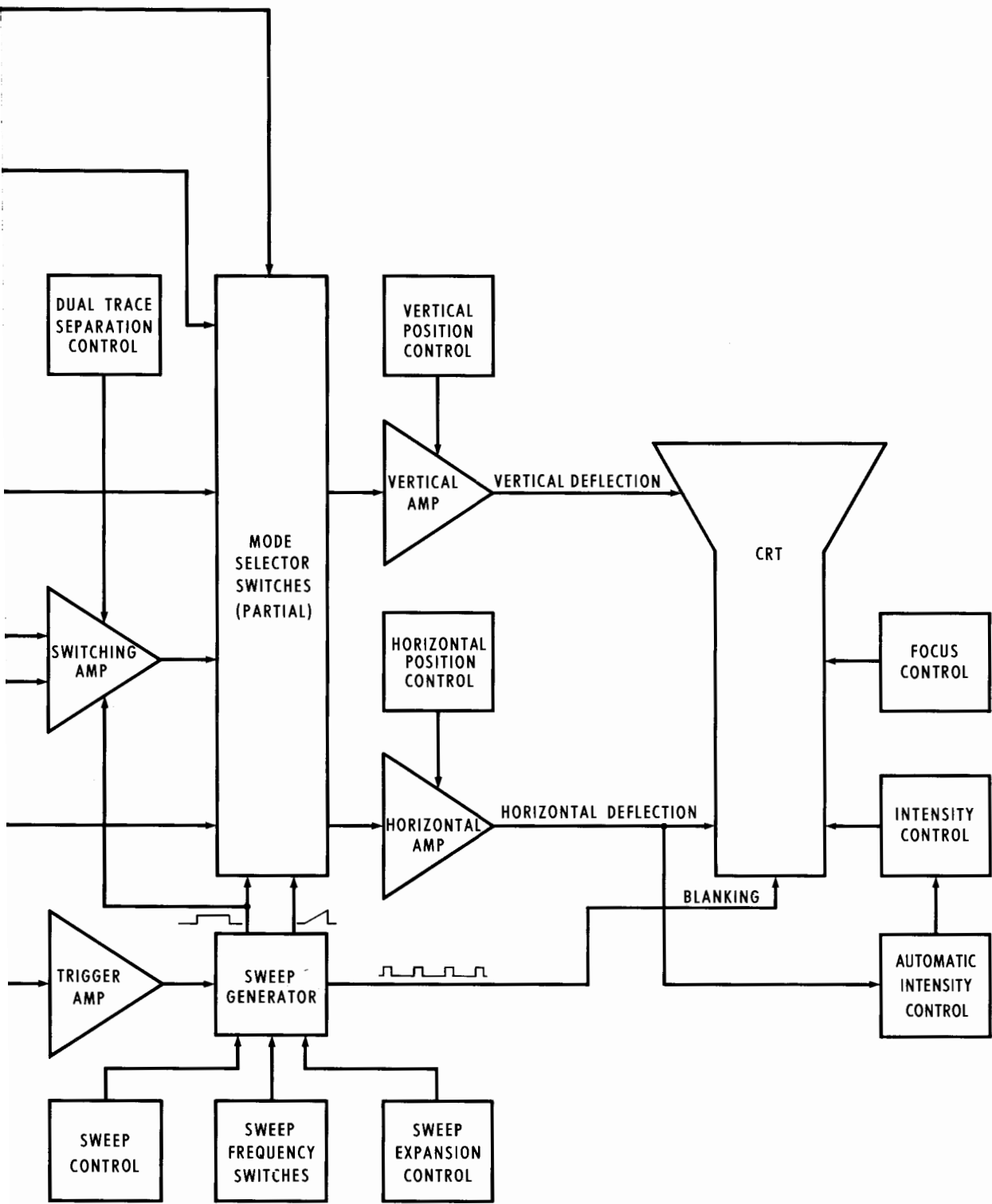

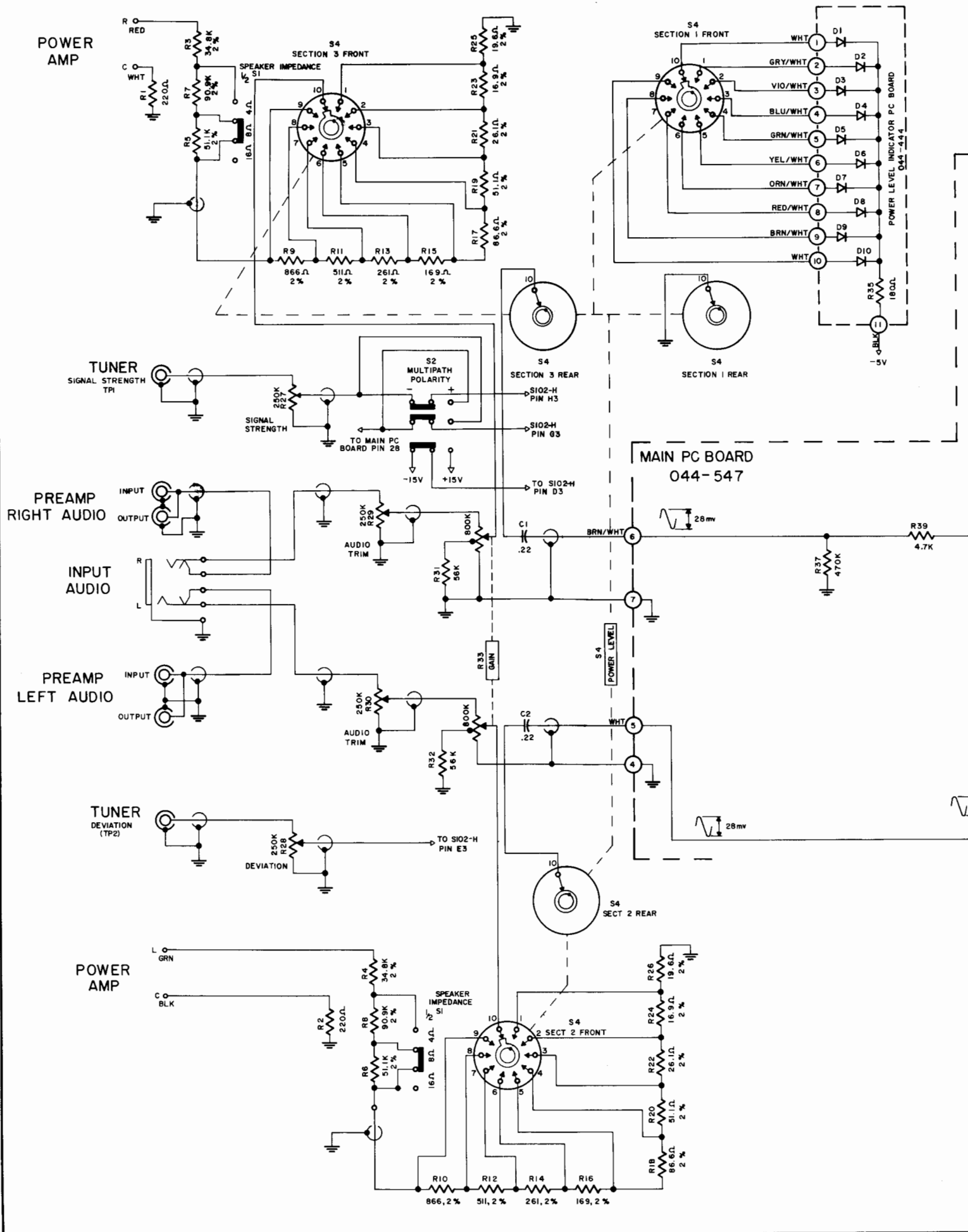

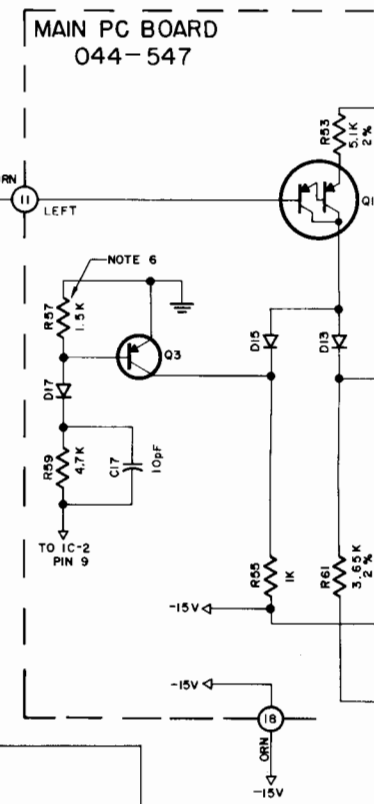
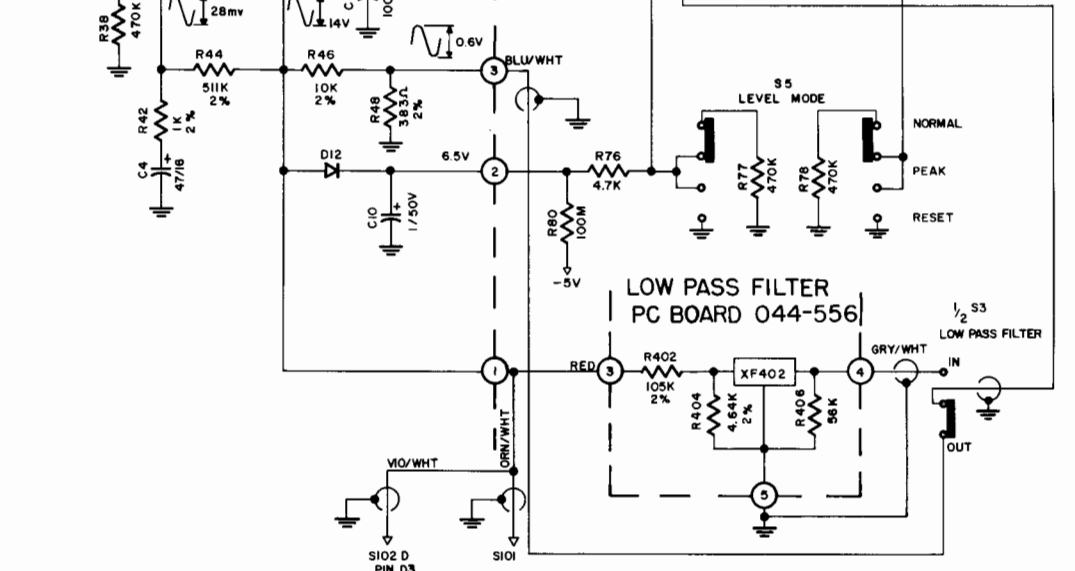
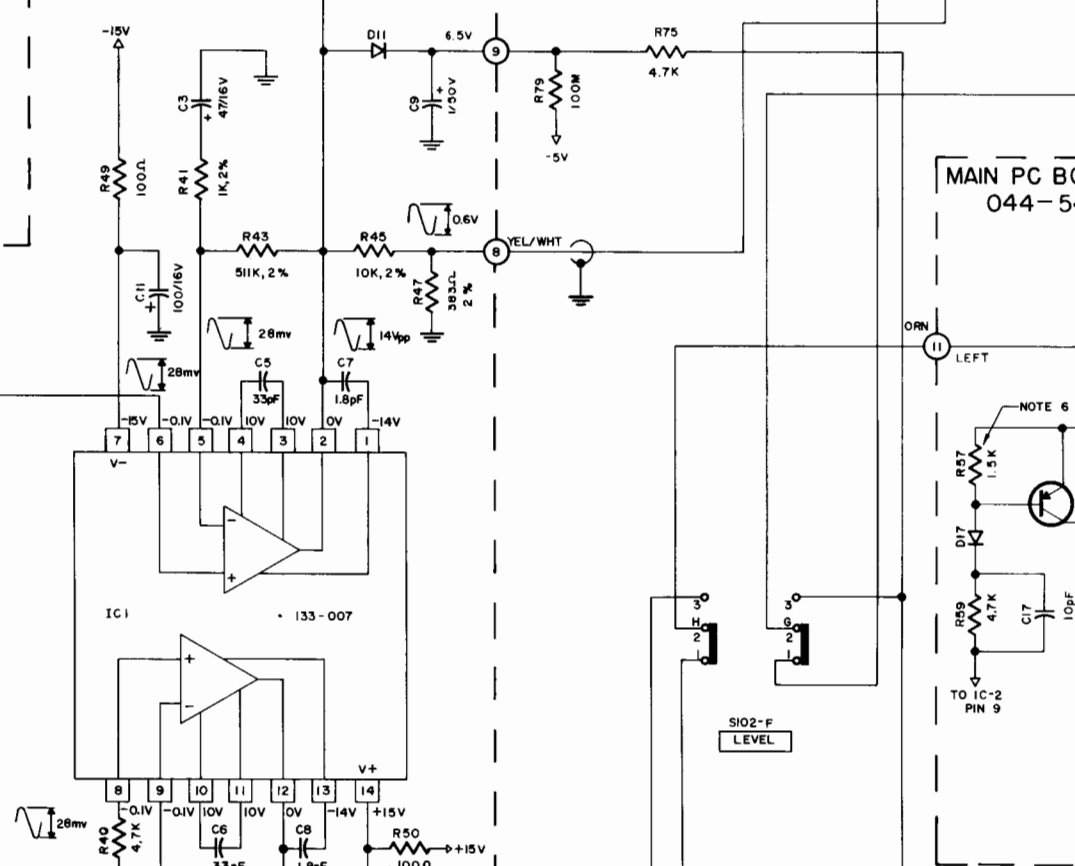
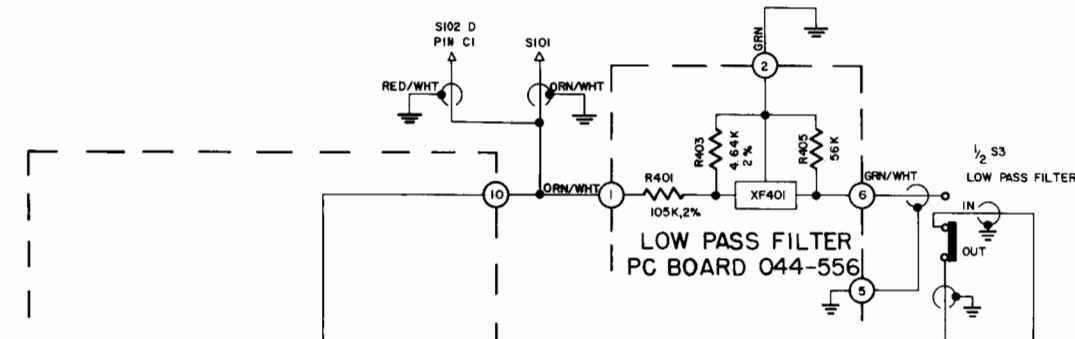
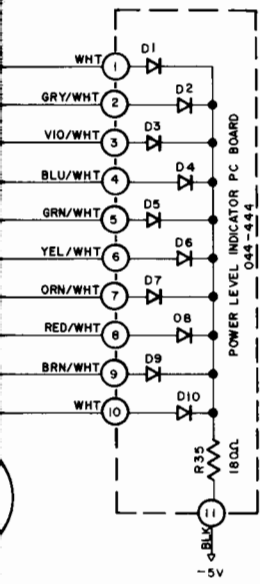

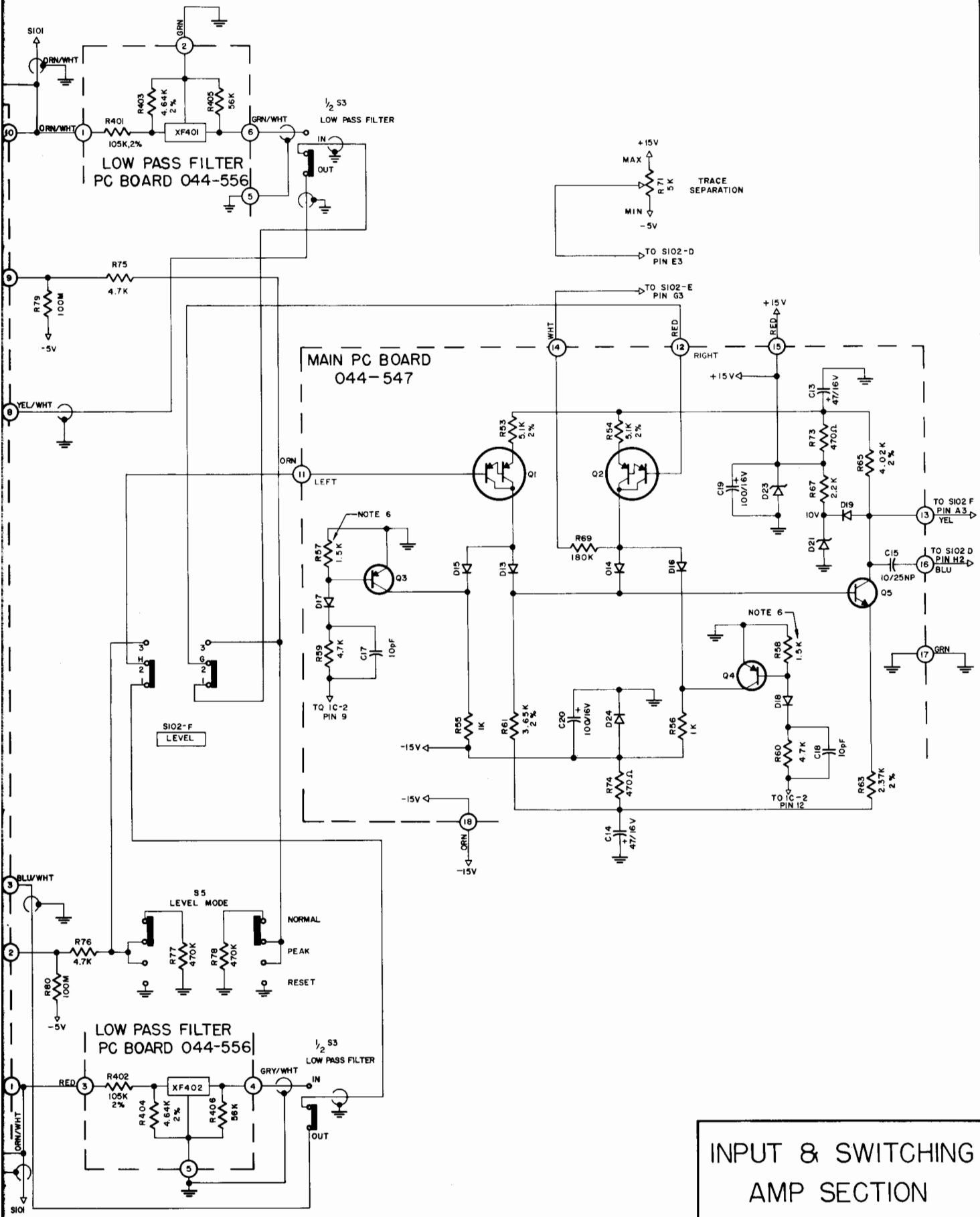

INPUT & SWITCHING  
AMP SECTION



POWER LEVEL PC BOARD 044-444

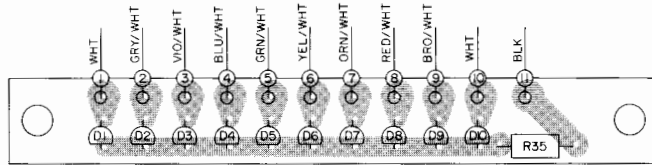

MAIN PC BOARD 044-5

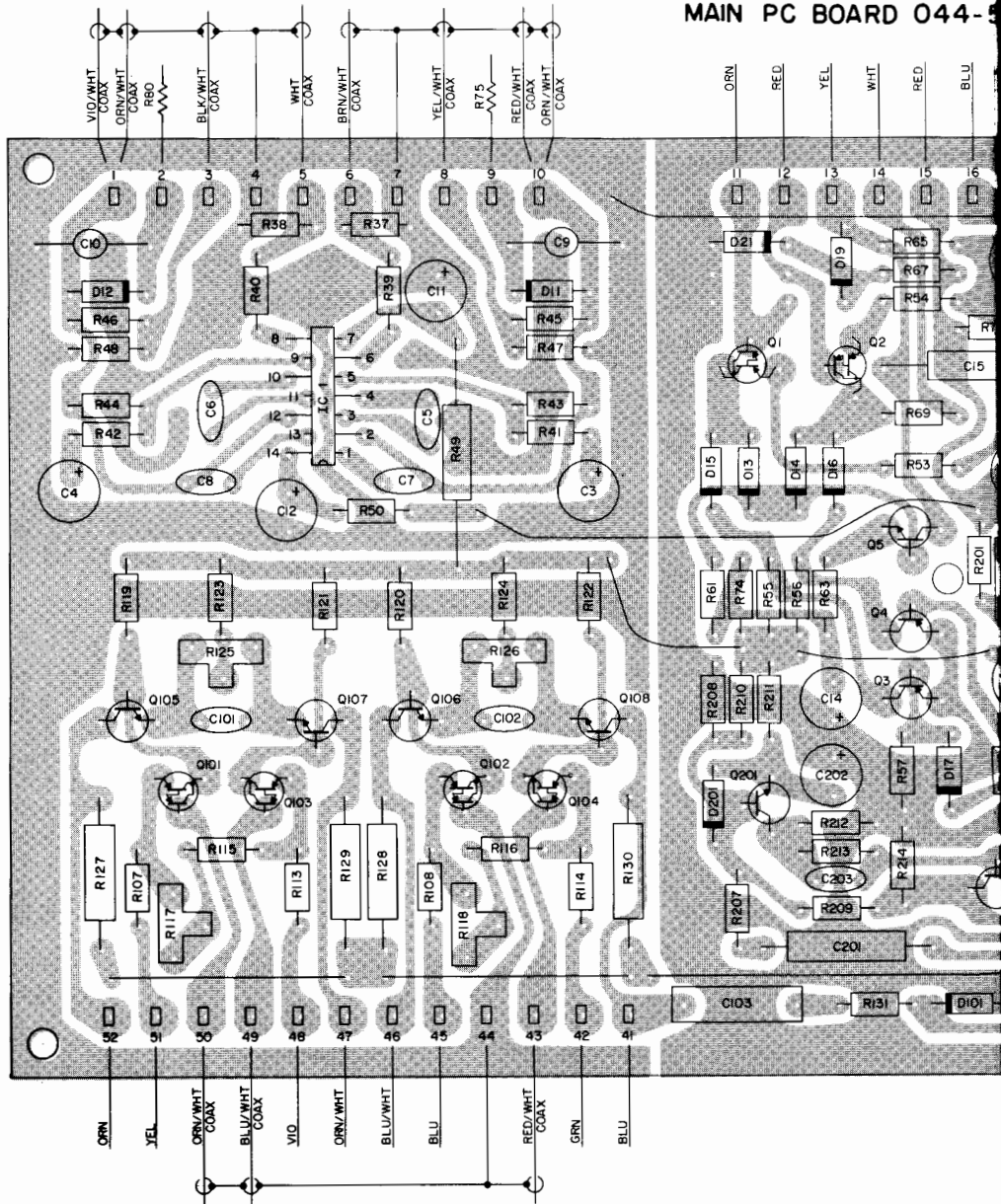

LOW PASS FILTER PC BOARD 044-556

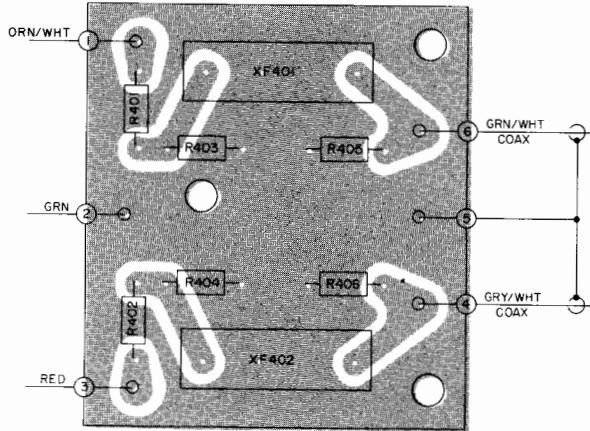

PC BOARD 044-547

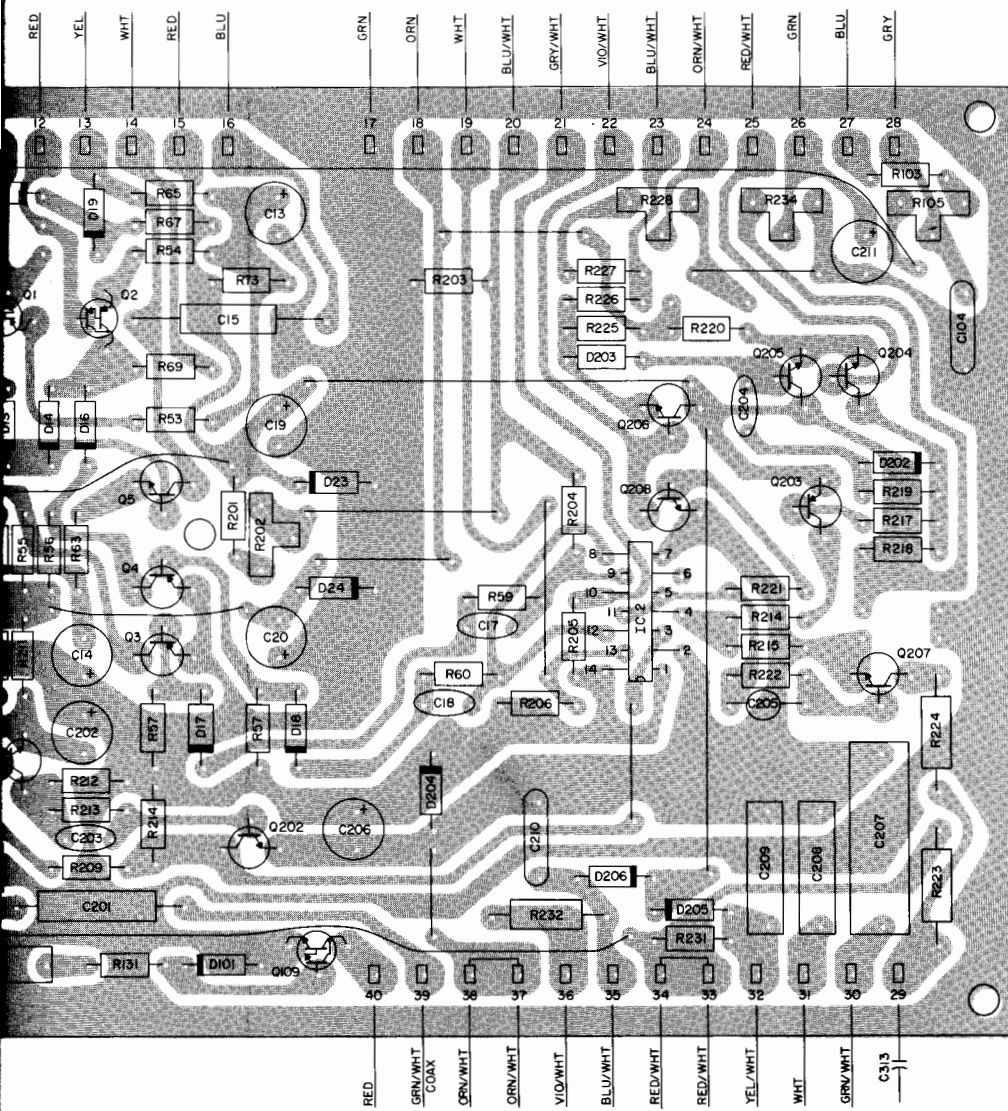

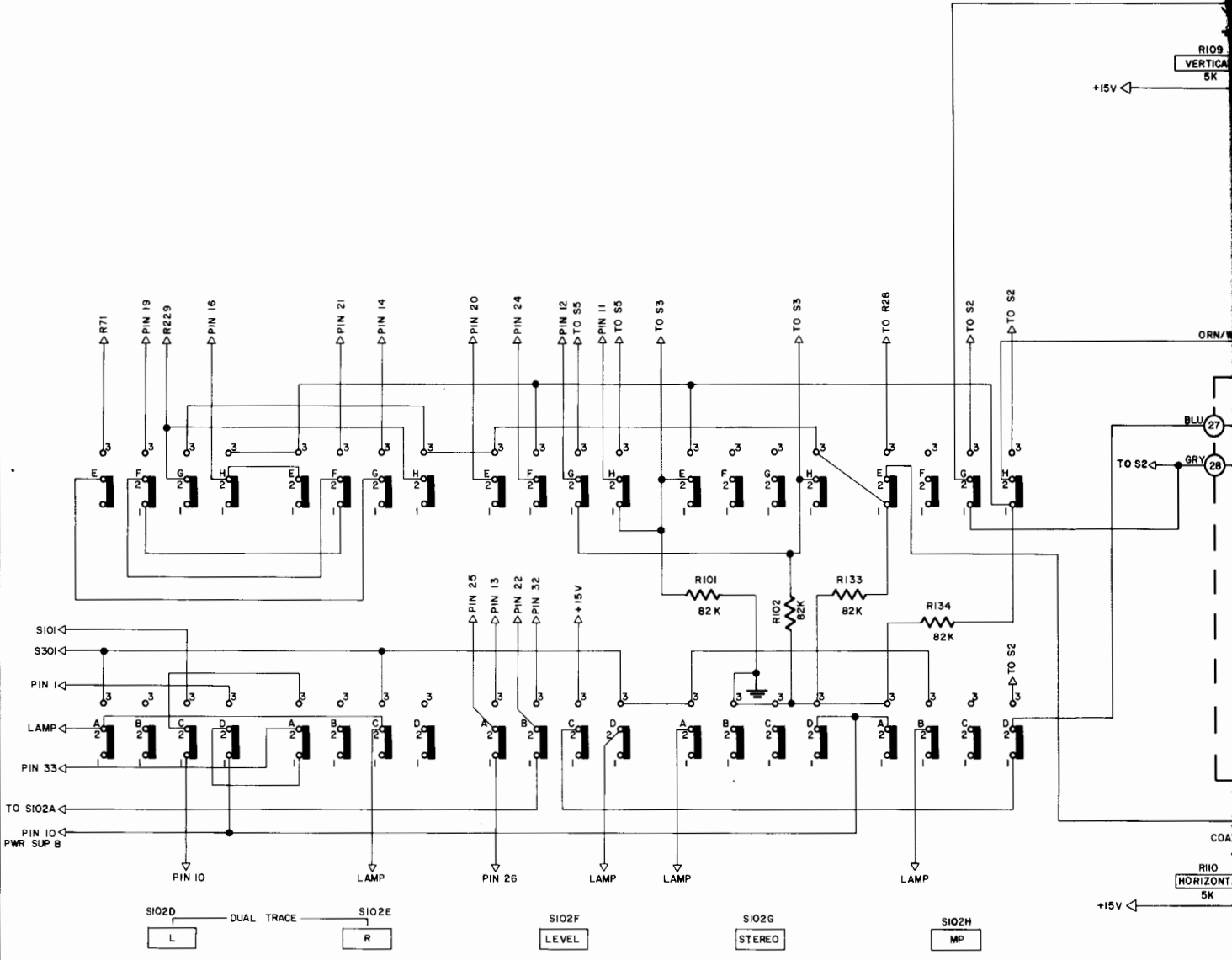

SIO2D DUAL TRACE SIO2E  
L R

SIO2F  
LEVEL

SIO2G  
STEREO

SIO2H  
MP

R109  
VERTICAL  
5K

ORN/W

BLU 27

TO S2 GRY 28

COAX

R110  
HORIZONTAL  
5K

MAIN PC BOARD  
044-547

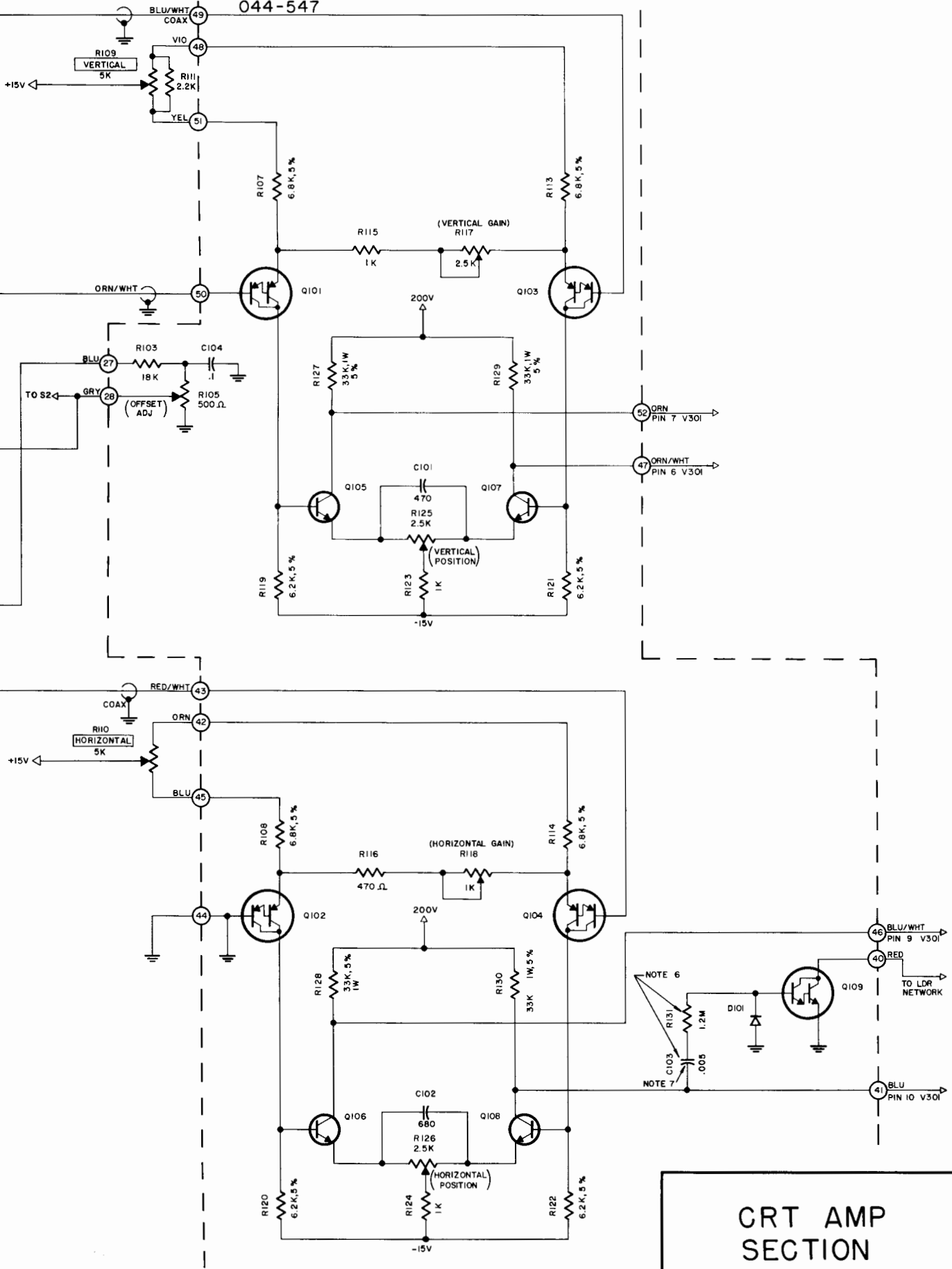

CRT AMP  
SECTION

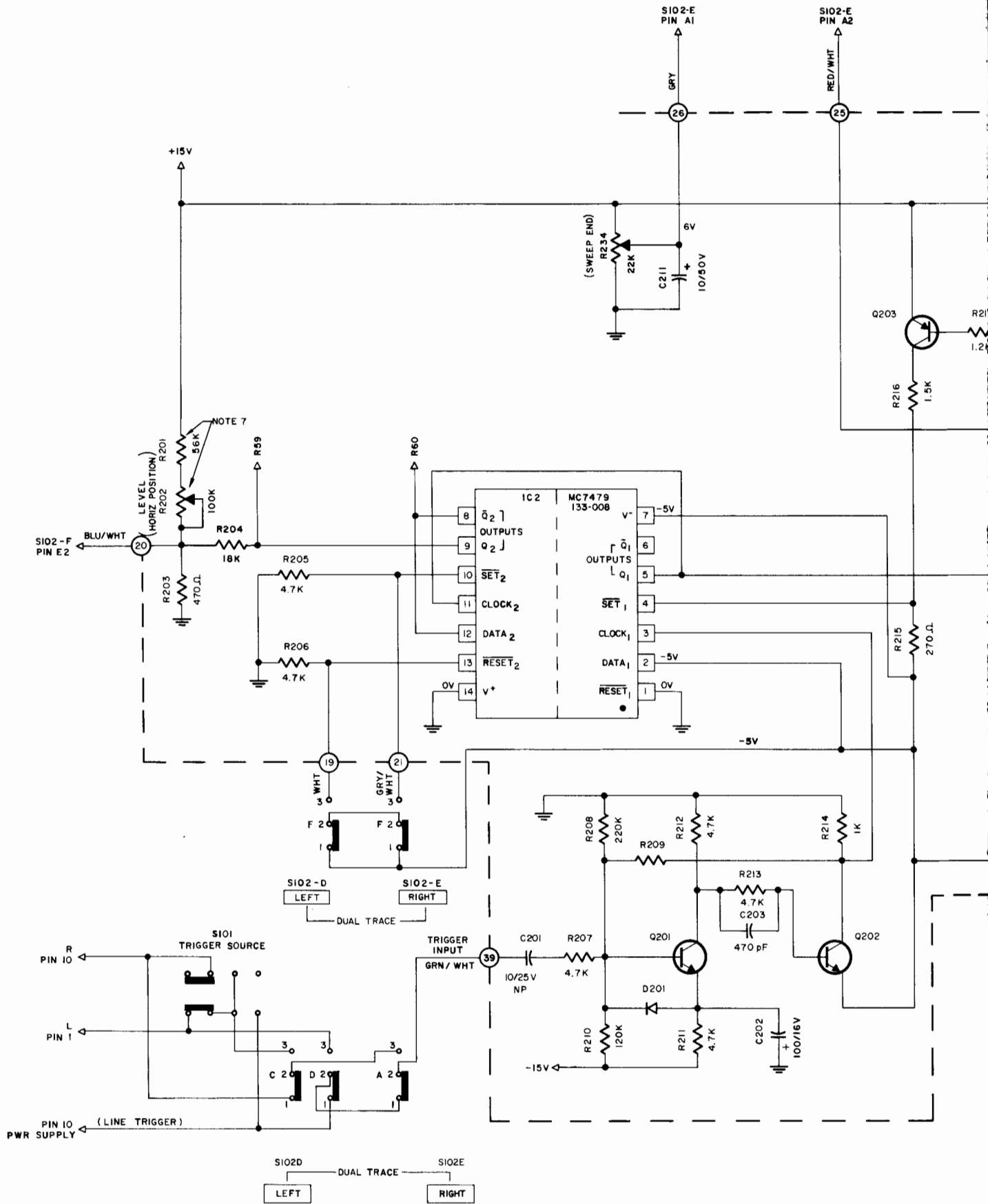

MAIN PC BOARD  
044-547

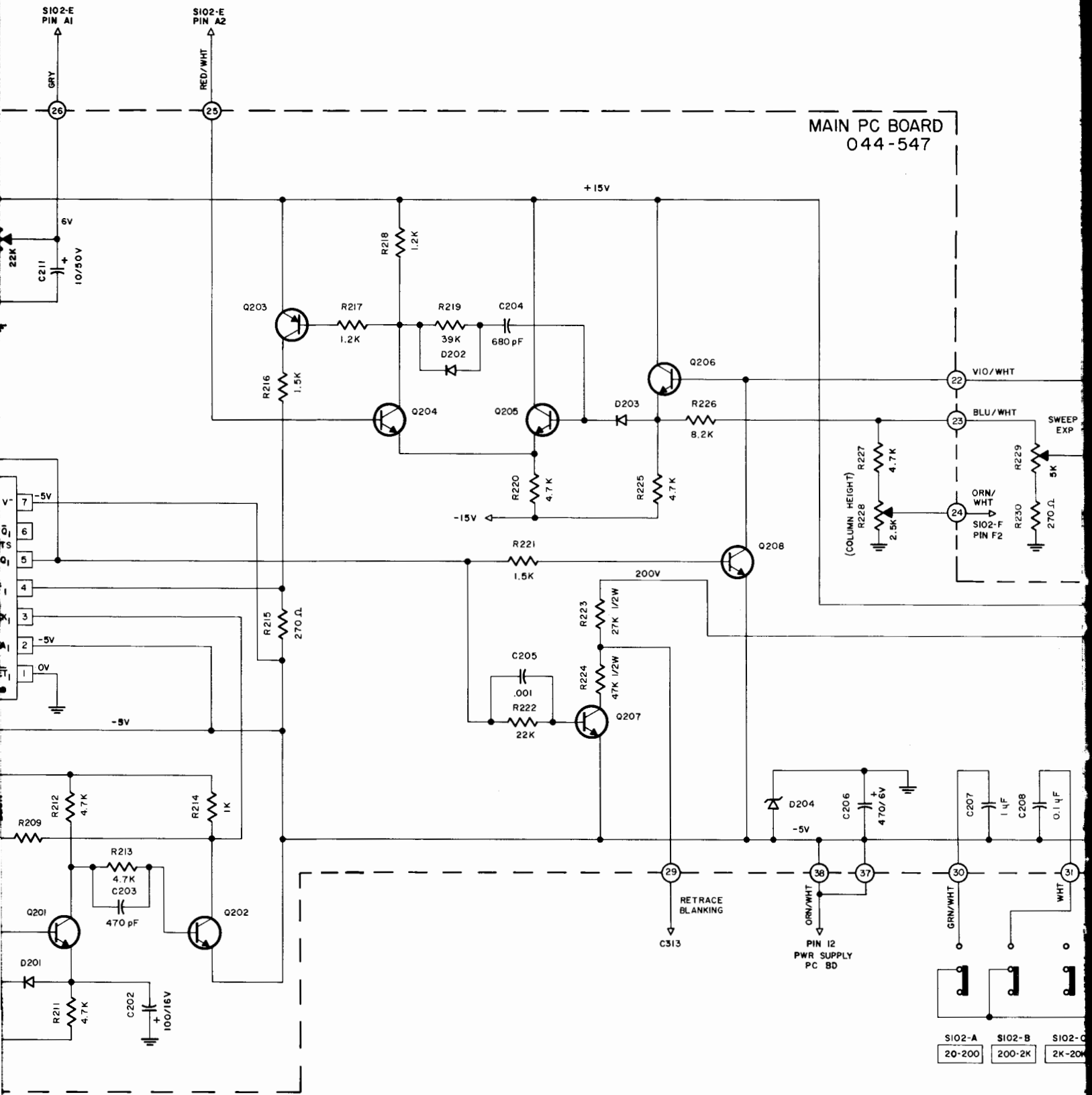

SIO2-A	SIO2-B	SIO2-C
20-200	200-2K	2K-20K

MAIN PC BOARD  
044-547

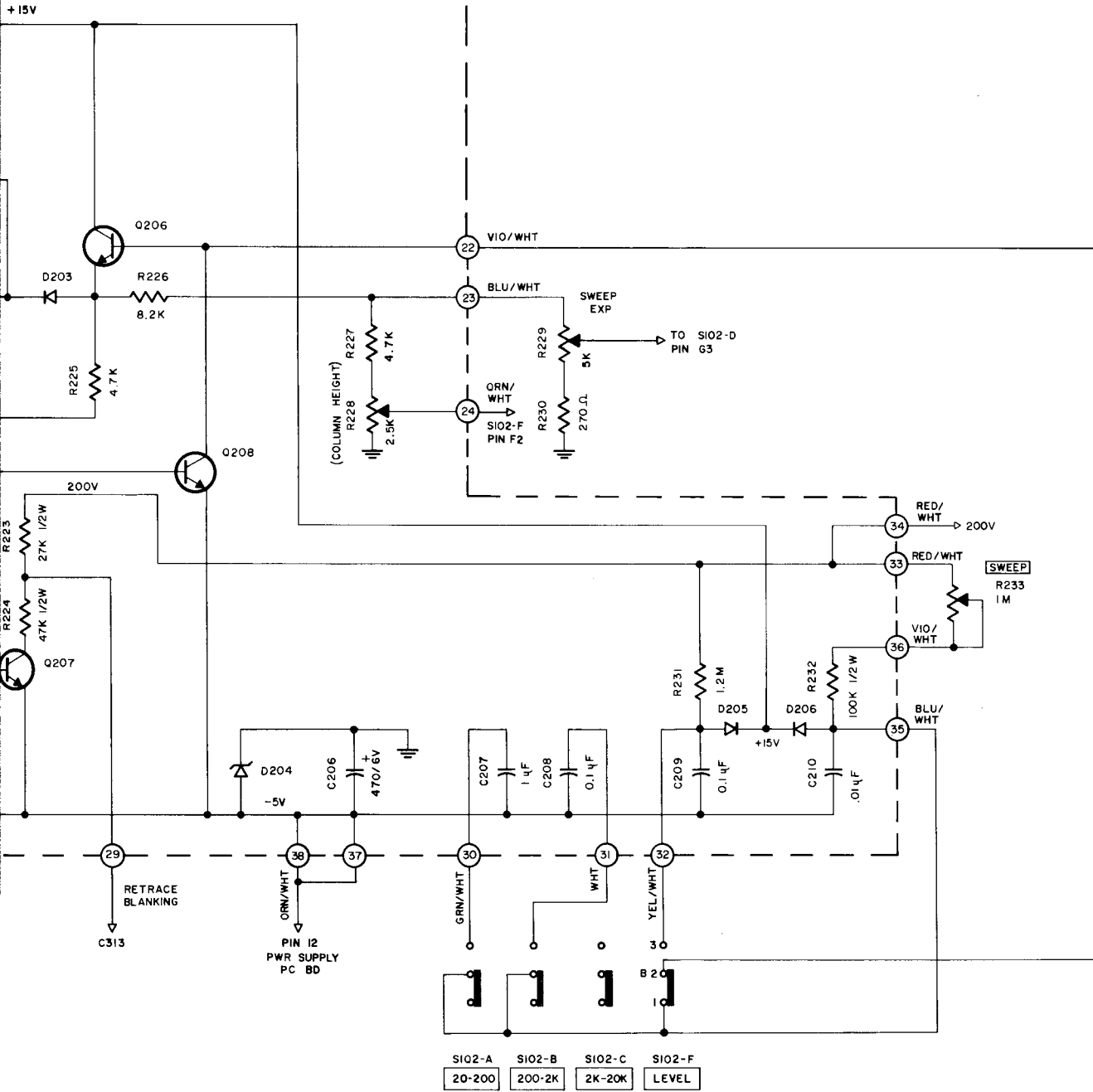

SWEEP SECTION

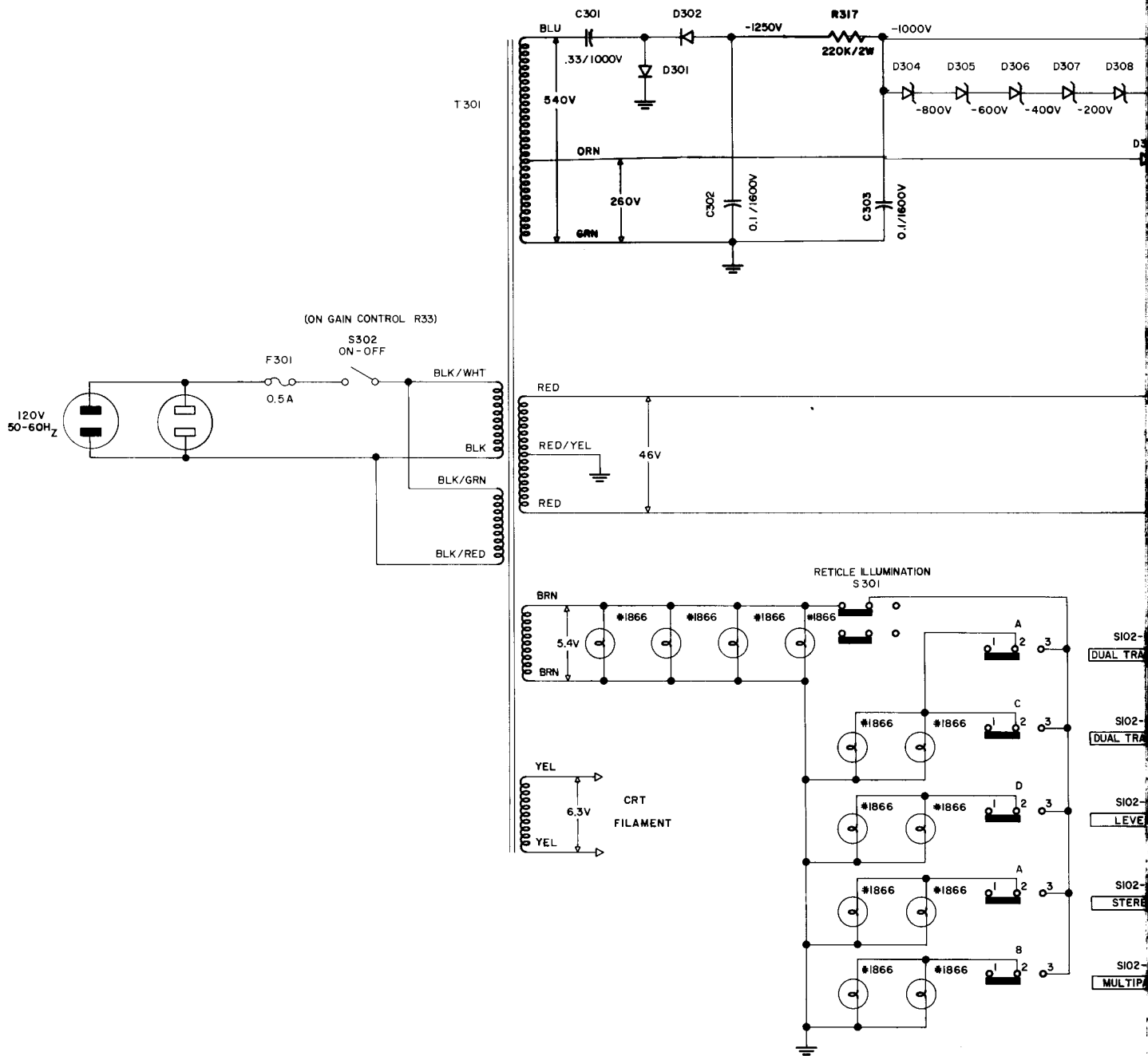



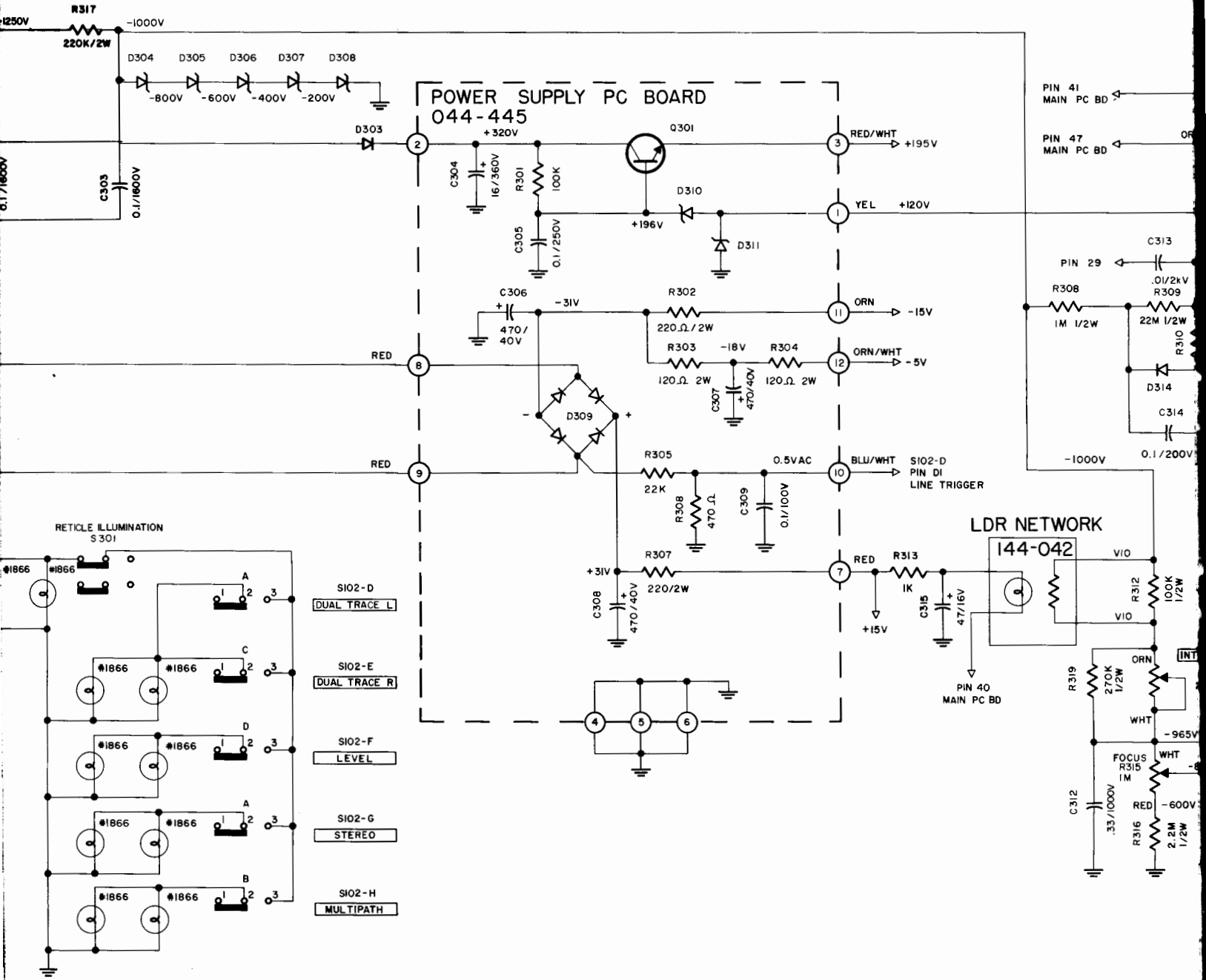

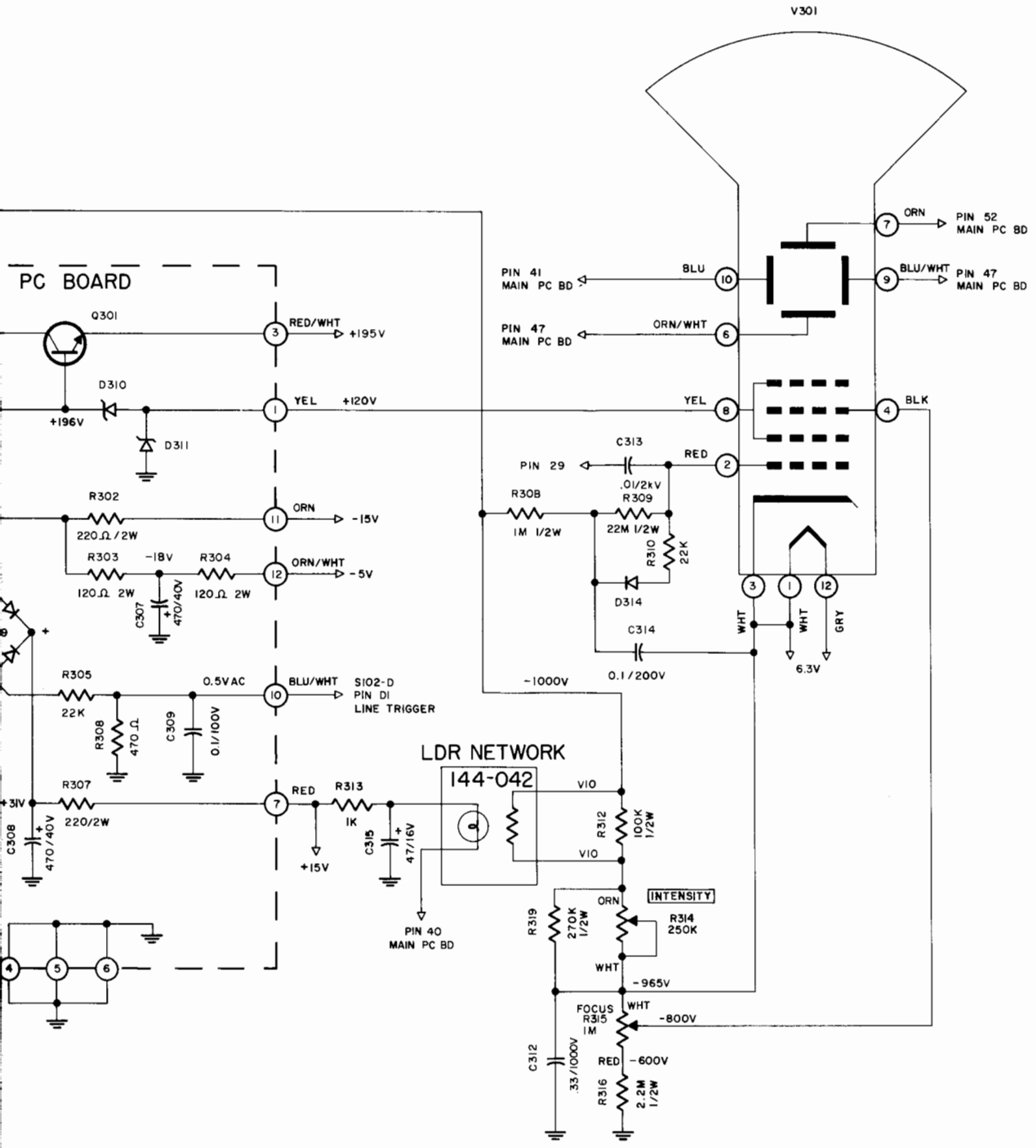

**POWER SUPPLY SECTION**  
MPI-4 154-600

POWER SUPPLY PC BOARD 044-445

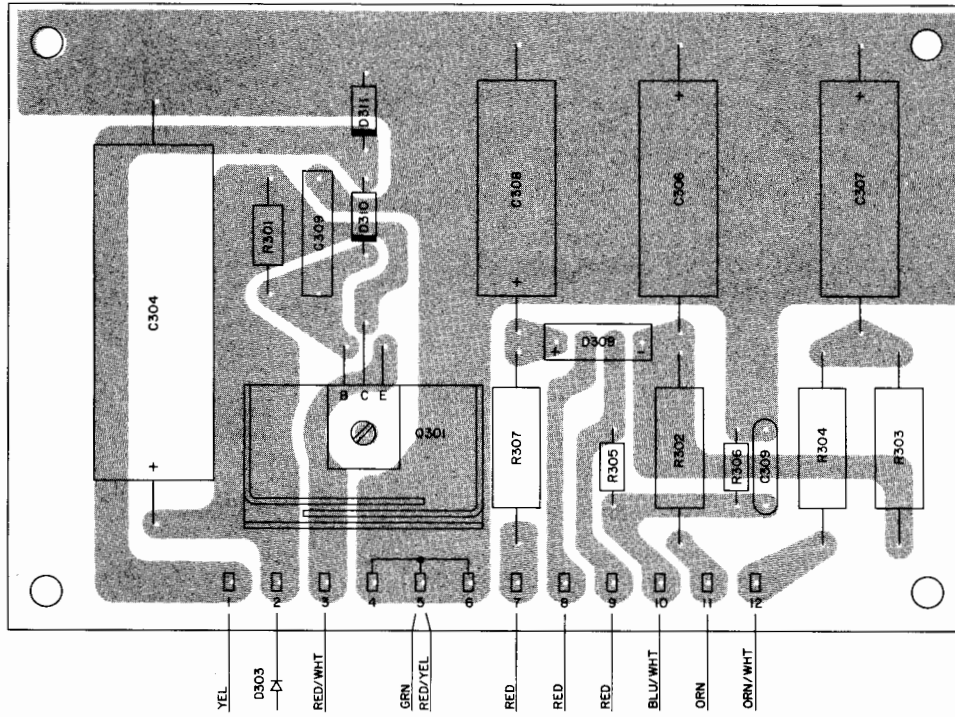

## ALIGNMENT INSTRUCTIONS

Vertical Position: STEREO With the front panel verticle control in the middle of its range adjust R125 so that the spot is located in the center of the reticle. (Fig. 1)

Horizontal Position: STEREO With the front panel horizontal control in the middle of its range adjust R126 so that the spot is located in the center of the reticle. (Fig. 1)

"Level" Horizontal Position: LEVEL Adjust R202 so that the two level lines are equally spaced about the center. (Fig. 2)

Horizontal Gain: LEVEL Adjust R118 so that the two level lines are located outside the calibration lines and inside the first marks on the Horizontal scale. (R126 may have to be readjusted to bring the spot to the center again) (Fig. 2)

Vertical Gain: STEREO For a monophonic input adjust R117 so that the diagonal falls between the "L+R" limit lines. If the preamp input is used, it is best to have both the trim controls and the gain control fully clockwise. (R125 may have to be readjusted to bring the spot to the center again) (Fig. 3)

Offset Adjustment: LEVEL With no input and the level mode in its "normal" position adjust R105 so that the tops of the two level lines are even with the bottom of the level scale. (This control also determines the offset for the multipath). (Fig. 4)

Column Height: LEVEL With the input over driven adjust R228 so that the tops of the two level lines are even with the +3 mark on the level scale. (R105 may have to be readjusted) (Fig. 5)

Sweep End: DUAL TRACE  
(R234) L R With the trigger set to "line" and no input, set the sweep expansion control (level set panel) so that the sweep starts at the left boundary, then adjust R234 so that the sweep stops at the right boundary. (Fig. 6)

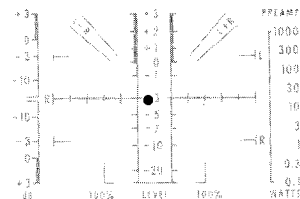

FIG. 1

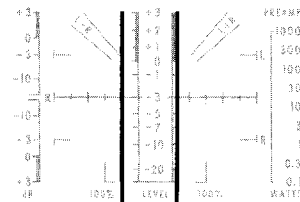

FIG. 2

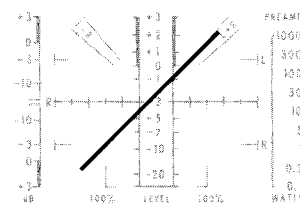

FIG. 3

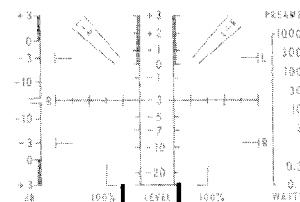

FIG. 4

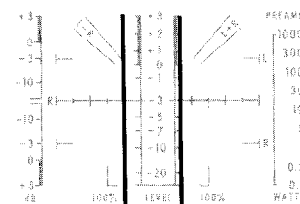

FIG. 5

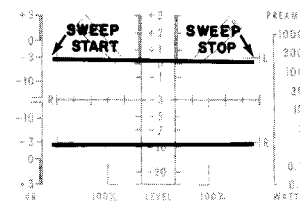



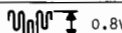

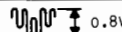

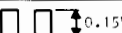



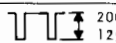

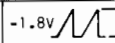
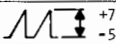
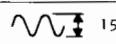
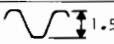



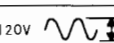
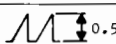
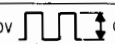
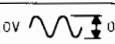

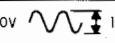
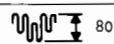
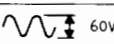
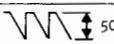
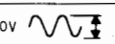
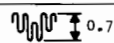
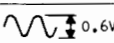
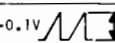
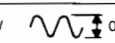
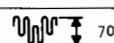
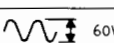
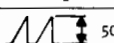
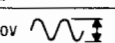



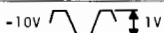



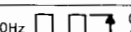



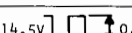
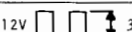

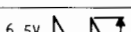
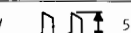

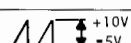
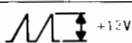
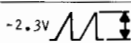







FIG. 6











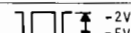

# MAIN PC BOARD

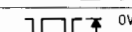
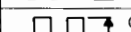
PINS 1 THRU 10 SEE SCHEMATIC

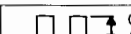
PIN	DUAL TRACE	L SWEEP	R SWEEP	LEVEL	STEREO	MULTIPATH
11		0V  0.6V		6.5V	0V  0.6V	
12		0V  0.6V		6.5V	0V  0.6V	
13	-0V  0.8V	0V  0.6V		7.5V	0V  0.6V	
14	5V	-12V	4V	-10V	-4V	-12V
15	+15V					
16	-0V  0.8V	0V  0.6V		0 - 10V	0V  0.6V	
17	0V GND					
18	-15V					
19	0V	-5V			0V	
20	0V  0.15V	-0.07V	+0.07V	0V  0.15V	0V	
21	0V		-5V		0V	
22		 10V / -5V				-5V
23		 2V / -2V				-2V
24		 0.4V / -0.3V				-0.3V
25		6V		7V		6V
26	6V					
27		0V		15V	0V	+15V / -15V
28		0V		0.26V	0V	+0.26V / -0.26V
29	195V  200V / 125V		160V  200V / 125V			125V
30	0.5V  +7V / -5V		+15V			-5V
31	0V - IF 200-2K BUTTON NOT PRESSED OTHERWISE SIMILAR TO PIN 30					
32		+15V		 -1.8V / +8V / -5V		+15V
33	+200V					
34	+200V					
35	0.5V  +7V / -5V		+15V			-5V
36	200V FOR SWEEP CONTROL CW 20V FOR SWEEP CONTROL CCW					
37	-5V					
38	-5V					
39	0V  15V		0V  1.5V		0V	
40		5V  10V				15V
41	120V  90V		120V  22V	120V  90V		120V
42	11V (DEPENDENT ON HORIZONTAL CONTROL [ 10V - 15V ] )					
43	0V  0.5V		0V  0.15V	0.0V  0.6V		0V
44	0V GND					
45	11V (DEPENDENT ON HORIZONTAL CONTROL [ 10V - 15V ] )					
46	120V  100V		120V  22V	120V  100V		120V
47	110V  80V	110V  60V		140V  50V	110V  50V	130V
48	12V (DEPENDENT ON VERTICAL CONTROL [ 11V - 15V ] )					
49		0V		0.2V	0V	0V (-MP POLARITY) 0.2V (+MP POLARITY)
50	0V  0.7V	0V  0.6V		-0.1V  0.5V	0V  0.5V	-0.2V (-MP POLARITY) 0V (+MP POLARITY)
51	12V (DEPENDENT ON VERTICAL CONTROL [ 12V - 15V ] )					
52	110V  70V	110V  60V		80V  50V	110V  50V	90V

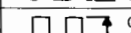
TSTR	DUAL TRACE	L SWEEP	R SWEEP	LEVEL	STEREO	MULTIPATH		
Q1	C	-8.4V	-4.3V	-12V				
	B	0V		6.5V	0V			
	E	1.1V		0.6V	7.3V	1.1V		
Q2	C	-4V	-12.3V	-4.3V				
	B	0V		0.6V	6.5V	0V		
	E	1.1V		0.6V	7.3V	1.1V		
Q3	C	-6.5V	-0.2V	-13V	-7V	0V OR -13V		
	B	-0.4V	-0.7V	0V	-0.4V	0V OR -0.7V		
	E	0V GND						
Q4	C	-6.5V	-13V	-0.2V	-7V	0V OR -13V		
	B	0.4V	0V	-0.7V	-0.4V	0V OR -0.7V		
	E	0V GND						
Q5	C	-0V	0V		7.5V	0V		
	B	-5V	-5V		-9.5V	-5V		
	E	-5.7V	-5.7V		-10.2V	-5.7V		
Q101	C	-5V	-5V		-4V	-5V		
	B	0V	0V	0.6V	-0.1V	0V		
	E	1.1V	1.1V		1V		1.1V	
Q102	C	-5.3V		4V	-5.3V		-5.3V	
	B	0V GND						
	E	1.1V		0.03V	1.1V		1.1V	
Q103	C	-5.3V	-5.3V		-6.5V	-5.3V		
	B	0V	0V	0V	0.2V	0V	0V	
	E	1.1V	1.1V		0.02V		1.1V	
Q104	C	-5.3V		4V	-5.3V		-5.3V	
	B	0V		0.5V	0V		0.0V	
	E	1.1V		0.5V	1.1V		1.1V	
Q105	C	110V	110V		80V	110V		
	B	-5V	-5V		-4V	-5V		
	E	-5.7V	-5.7V		-4.5V		-5.7V	
Q106	C	120V		100V	120V		120V	
	B	-5.3V		4V	-5.3V	-5.3V		
	E	-5.8V		3.5V	-5.8V	-5.8V		
Q107	C	110V	110V		140V	110V		
	B	-5.3V	-5.3V		-6.5V	-5.3V		
	E	-5.8V	-5.8V		2V		-5.8V	
Q108	C	120V		90V	120V		120V	
	B	-5.3V		4V	-5.3V	-5.3V		
	E	-5.8V		4V	-5.8V	-5.8V		
Q109	C	5V			10V		15V	
	B	0.4V		+1.5V		+1.5V	0V	
	E	0V GND						

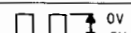
TSTR	DUAL TRACE	L SWEEP	R SWEEP	LEVEL	STEREO	MULTIPATH	
Q201	C	-6V  8V			-7.5V		
	B	-10V  1.5V		-10V  1V	-7V		
	E	-10V  0.01V		-10V  0.1V	-7.6V		
Q202	C	0V  -5V			60Hz  -5V	0V	
	B	-7V  6V			-7.5V		
	E	-5V					
Q203	C	+14V  +15V -5V		14.5V  +15V -5V	+15V		
	B	14.5V  0.8V			14.5V		
	E	+15V					
Q204	C	12V  3V			12V		
	B	5.5V		7.2V	5.5V		
	E	5V  2.5V		6.5V  2.5V		5V	
Q205	C	+15V					
	B	3V  5V			0V		
	E	5V  2.5V		6.5V  2.5V		5V	
Q206	C	+15V					
	B	 +10V -5V			-5V		
	E	0V  +1.2V		-2.3V  1.4V		-5.5V	
Q207	C	185V  +196V -5V		95V  +196V -5V		-5V	
	B	-5V  0.5V		-4.6V  0.5V		-4.4V	
	E	-5V					
Q208	C	 +1.0V -5V			-5V		
	B	-5V  0.6V		-4.6V  0.6V		-4.3V	
	E	-5V					

IC-2	DUAL TRACE	L SWEEP	R SWEEP	LEVEL	STEREO	MULTIPATH	
1	0V						
2	-5V						
3	0V  -5V		60Hz  -5V		0V		
4	-2V  -5V			-2V			
5	-2V  -5V		-2V  -5V		-2V		
6	0V  -5V		0V  -5V		-5V		
7	-5V						
8	0V  -5V	0V	-5V	0V  -5V	-5V OR 0V		
9	0V  -5V	-5V	0V	0V  -5V	-5V OR 0V		
10	0V		-5V	0V			
11	-2V  -5V			-2V  -5V		-2V	
12	0V  -5V	0V	-5V	0V  -5V	-5V OR 0V		
13	0V	-5V	0V				
14	0V						

# SCHEMATIC NOTES

1. Unless otherwise specified: Resistance values are in ohms, 1/4 watt, and 10% tolerance; Capacitance values smaller than 1 are in microfarads ( $\mu\text{F}$ ); capacitance values greater than 1 are in picofarads (pF); inductors are in microhenries ( $\mu\text{H}$ ).
2. Printed circuit board components are outlined on the schematics by dotted lines. The circled numbers around the dotted lines correspond to the numbers on the PC Board layouts.
3. The terminal numbering of rotary switches is for reference only.
4. All voltages indicated are measured under the following conditions:
  - a. Use of an 11 megohm input impedance VTVM.
  - b. Tuner Input: None
  - c. Preamp Input: 10 MV rms, 1kHz (Left & Right)
  - d. Power Amp Input: None
  - e. Controls At:
 

Sweep:	Fully clockwise	Filter:	Out
Vertical:	Center	Trigger Source:	Left
Horizontal:	Center	Trace Separation:	Normal
Intensity:	Normal	Sweep Expansion:	Normal (X1)
Power Level:	Preamp	Trim:	Fully clockwise
Gain:	Fully clockwise	Sweep Frequency:	20 - 200
Level Mode:	Normal		
  - Mode Selector: Refer to "Voltage and Waveform" chart for voltages at PC Board, transistor and IC pins. Voltages change with the positions of the mode selector pushbutton switch. Voltages that are not affected by the mode selector are on the schematic diagram.
 

All voltages are D.C. except those shown with an A.C. signal. If a pin has both a D.C. voltage and an A.C. signal the D.C. voltage is written first.
5. The voltages shown are typical and will not necessarily be the same for every unit. Variations of  $\pm 25\%$  are not unusual.
6. In units with Serial No's below AF2175 R57 & R58 are 1K; R131 is 220K and C103 is  $.022\mu\text{F}$ .
7. In units with Serial No's below AF1588 C103 is  $.22\mu\text{F}$ ; R201 is 33K and R202 is 500K.

All parts  
available from

Replaced  
by PART

Symbol  
Number

C1,2

C3,4

C9,10

C11,12

C13,14

C15

C103

C201

C202

C206

C207

C208,209

C210

C211

C301

C302,303

C304

C305

C306,307

C308

C310,311

C312

C314

C315

D1,2

D3,4

D5,6

D7,8

D9,10

D11,12

D13,14



## REPLACEMENT PARTS

All parts not listed are common items obtainable from radio parts jobbers.

Replacement parts may be obtained when ordered by PART NUMBER from:

McIntosh Laboratory, Inc.  
Customer Service Department  
2 Chambers Street  
Binghamton, New York 13903  
(telephone 607-723-3512)

## CAPACITORS

Symbol Number	Description	Part Number
C1,2	Mylar .22 $\mu$ F 200V	064-043
C3,4	Elect 47 $\mu$ F 16V	066-182
C9,10	Tant Elect 1 $\mu$ F 50V	066-242
C11,12	Elect 100 $\mu$ F 16V	066-226
C13,14	Elect 47 $\mu$ F 16V	066-182
C15	Elect 10 $\mu$ F 50V	066-222
C103	Mylar .22 $\mu$ F 250V	064-068
C201	Elect 10 $\mu$ F 50V	066-222
C202	Elect 100 $\mu$ F 16V	066-226
C206	Elect 470 $\mu$ F 6V	066-197
C207	Mylar 1 $\mu$ F 250V	064-088
C208,209	Mylar .1 $\mu$ F 250V	064-067
C210	Mylar .01 $\mu$ F 250V	064-101
C211	Elect 10 $\mu$ F 50V	066-221
C301	Paper .33 $\mu$ F 1000V	064-109
C302,303	Paper .1 $\mu$ F 1600V	064-110
C304	Elect 16 $\mu$ F 350V	066-196
C305	Mylar .1 $\mu$ F 250V	064-067
C306,307	Elect 470 $\mu$ F 40V	066-134
C308	Elect 470 $\mu$ F 40V	066-134
C310,311	Elect 100 $\mu$ F 16V	066-226
C312	Paper .33 $\mu$ F 1000V	064-109
C314	Mylar .1 $\mu$ F 200V	064-067
C315	Elect 47 $\mu$ F 16V	066-182

## DIODES

D1,2	Light emitting diode	070-056
D3,4	Light emitting diode	070-056
D5,6	Light emitting diode	070-056
D7,8	Light emitting diode	070-056
D9,10	Light emitting diode	070-056
D11,12	Si. signal diode	070-047
D13,14	Si. signal diode	070-047

D15,16	Si. signal diode	070-047
D17,18	Si. signal diode	070-047
D19	Si. signal diode	070-047
D21	Zener diode 10V	070-024
D101	Si. signal diode	070-047
D201,202	Si. signal diode	070-047
D203	Si. signal diode	070-047
D204	Zener diode 4.7V	070-057
D205,206	Si. signal diode	070-047
D301,302	Diode 2000V	070-058
D303	Diode 800V	070-059
D302,305	Zener diode 200V	070-060
D306,307	Zener diode 200V	070-060
D308	Zener diode 200V	070-060
D309	Bridge Rectifier	070-044
D310	Zener diode 75V	070-025
D311	Zener diode 120V	070-062
D312,313	Zener diode 15V	070-061
D314	Si. signal diode	070-047

## TRANSISTORS

Q1,2	Si. PNP transistor	132-100
Q3,4	Si. PNP transistor	132-096
Q5	Si. NPN transistor	132-092
Q101,102	Si. PNP transistor	132-100
Q103,104	Si. PNP transistor	132-100
Q105,106	Si. NPN transistor	132-102
Q107,108	Si. NPN transistor	132-102
Q109	Si. NPN transistor	132-090
Q201,202	Si. NPN transistor	132-092
Q203	Si. PNP transistor	132-096
Q204,205	Si. NPN transistor	132-092
Q206	Si. NPN transistor	132-092
Q207	Si. NPN transistor	132-102
Q208	Si. NPN transistor	132-042
Q301	Si. NPN transistor	132-102

## FUSES

F301	Fuse 1/2A	089-009
------	-----------	---------

## POTENTIOMETERS

R27	Signal strength control	134-252
R28	Deviation control	134-252
R29	Audio trim control	134-252
R30	Audio trim control	134-252
R33	Gain control	134-251

R71	Trace separation control	134-219
R109	Vertical control	134-244
R110	Horizontal control	134-244
R233	Sweep control	134-250
R229	Sweep expansion control	134-219
R314	Intensity control	134-248
R315	Focus control	134-249

## SWITCHES

S1	Speaker impedance	148-033
S2	Multipath polarity	148-032
S3	Lo Pass filter	148-031
S4	Power level switch	146-161
S5	Level mode	148-034
S101	Trigger source	148-033
S102	Mode selector	150-011
S301	Reticule illumination	148-031

## TRANSFORMERS

T301	Power transformer	159-091
------	-------------------	---------

## TUBES

V301	Cathode ray tube	165-062
------	------------------	---------

## INTEGRATED CIRCUITS

IC1	Integrated circuit	133-007
IC2	Integrated circuit	133-008

## LAMPS

#1866	Front panel	058-014
#1866	Reticule illumination	058-014

## FRONT PANEL &amp; TRIM

	Front panel	044-439
	Front panel end caps	018-160
	Sweep knob	044-429
	Horizontal knob	044-429
	Vertical knob	044-429
	Intensity knob	044-429
	Power level knob	044-429
	Gain knob	044-430
	Focus knob	090-122
	trace separation knob	090-121
	Sweep expansion knob	090-121
	Signal strength knob	090-121
	Audio trim knob	090-121
	Pushbutton	017-128

## MISCELLANEOUS ITEMS

Plastic feet	017-156
Shipping carton	044-538
Push terminal strip	074-030
Owners manual	038-788
AC line cord	170-021
Fuse holder	170-033
Audio cable	176-135

## MOUNTING SYSTEM

Shelf bracket (right)	043-622
Shelf bracket (left)	043-623
Mounting template #100	038-179
Hardware package	044-440

## MODULES

LDR Network	144-042
-------------	---------